



ELEGANT

FURNITURE & LIGHTING™

Installation manual for:

V1800G48

Dimensions:D48" H86" L42

Collection:Primo

Bulb Type:E12 bulb not included

Lamp Frame Weight(lbs):37.2

Total Weight(lbs):351



Thank you for choosing our product(s).

Our Company is actively involved in every step of the production.

Our product(s) are designed to be utilized for every application that graces your home or business.

We pride ourselves in providing the most prompt and courtesy service to all of the valued customers.

Please find the enclosed detailed instruction and read carefully for proper installation.

If you have any questions, please contact the retailer where the purchased was made.



SAFETY

Warning: MAKE SURE THE ELECTRICITY TO THE WIRES YOU ARE WORKING ON IS SHUT OFF, BY EITHER REMOVING THE FUSE OR TURNING OFF THE CIRCUIT BREAKER.

CAUTION

- Before assembling the lighting fixture, please read all instructions carefully.
- All frame & crystal components are fragile, please handle with care.
- Required supply circuit : 110 - 130V/60Hz
- Labeled wires are "L" for live wire, "N" for neutral wire, "E" for ground wire.
- Never install fixture on damp ceiling, the room should be dry and well ventilated
- All electrical components must be installed by a licensed electrician and in accordance with the National Electrical Code and the appropriate local electrical codes.

Unpack the Package

Please open the box carefully and check all the items are inside the box. If you have any installation, assembling and missing parts questions, where you purchase from and any other relevant information ready, our customer service team will provide comprehensive and worry free service to our valued customers.

Frame Parts List

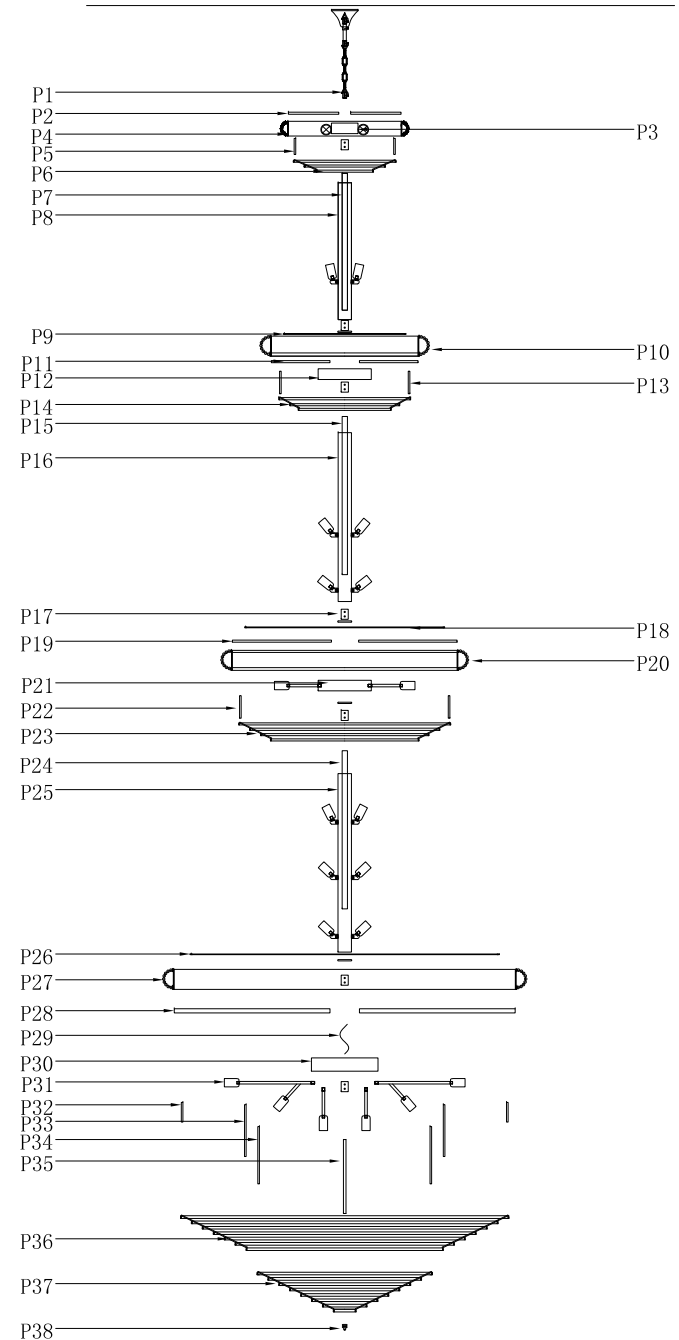







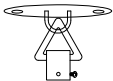

V1800G48 D48" H86" L42

Step 1

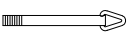
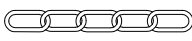
Please use the parts list to ensure you are not missing any parts









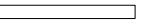
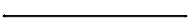
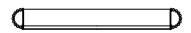

V1800G48

PARTS LIST

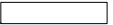
part	picture	Description	Parts Number	Qty	Check list
ZA		4" Crossbar	CP1020R67	1	
ZA		Crossbar		1	
ZB		6.7" Canopy		1	
ZC		Canopy ring		1	
ZD		ROD1020	ROD1020	1	
ZE		L59" CHAIN08P Plain Design	CHAIN08P	1	
ZF		Power Cord 12' SPT-2-16# Clear/Gold		1	
P1		Loop		1	
P2		6.5" Iron bracket		4	
P3		4" Metal wire box		1	
P4		Lamp body (1)		1	
P5		2.4" Iron bracket		4	



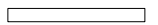





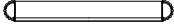

03

V1800G48 D48" H86" L42

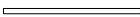
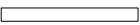











part	picture	Description	Parts Number	Qty	Check list
P6		13" Frame		1	
P7		15.3" Threaded pipe		1	
P8		17.3" Metal tube		1	
P9		14.7" Metal ring		1	
P10		Lamp body (2)		1	
P11		7.5" Iron bracket		4	
P12		6" Metal wire box		1	
P13		3.3" Iron bracket		4	
P14		16.3" Frame		1	
P15		21" Threaded pipe		1	
P16		23.3" Metal tube		1	
P17		Coupling		7	
P18		23.5" Metal ring		1	

04

V1800G48 D48" H86" L42

part	picture	Description	Parts Number	Qty	Check list
P19		11.8" Iron bracket		6	
P20		Lamp body (3)		1	
P21		7" Metal wire box		1	
P22		3.3" Iron bracket		6	
P23		25" Frame		1	
P24		22.4" Threaded pipe		1	
P25		24.4" Metal tube		1	
P26		38.6" Metal ring		1	
P27		Lamp body (4)		1	
P28		20.6" Iron bracket		12	
P29		Steel wire		1	
P30		7.8" Metal wire box		1	
P31		Socket		42	

V1800G48 D48" H86" L42

part	picture	Description	Parts Number	Qty	Check list
P32		3.3" Iron bracket		6	
P33		6.7" Iron bracket		6	
P34		7.5" Iron bracket		6	
P35		9.8" Threaded pipe		1	
P36		42" Frame		1	
P37		22.7" Bottom		1	
P38		Finial		1	
C		1050-14#*3pcs		525	
D		701-40#		763	
E		1050-14#*20pcs		36	
F		1050-14#*26pcs		54	
G		1050-14#*29pcs		90	

step 2 Canopy Installation Instruction

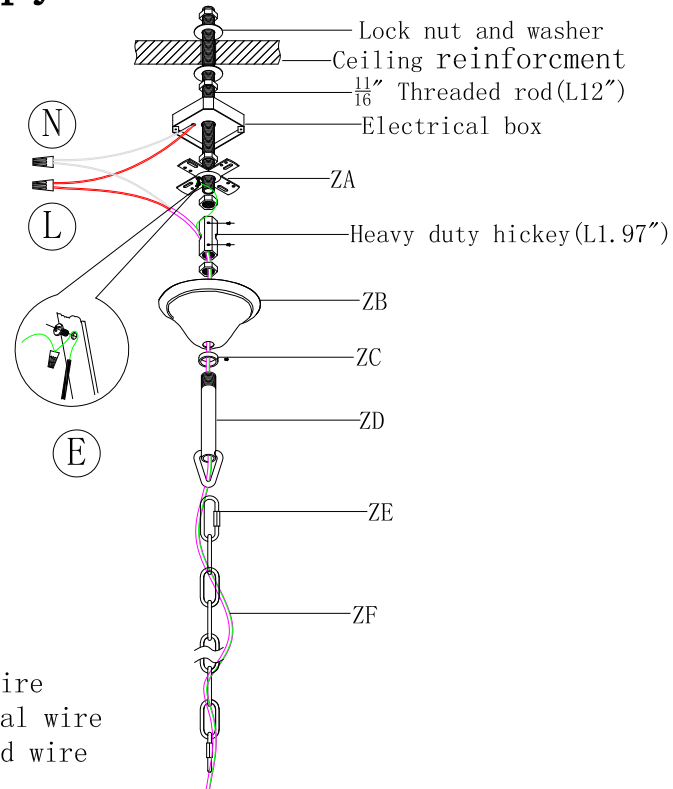

"L" = Hot wire
 "N" = Neutral wire
 "E" = Ground wire

IMPORTANT: Test sockets with bulb before dressing the fixture.

1. Drill a $\phi 0.7$ " hole in the ceiling reinforcement to allow a $\frac{1}{16}$ " threaded rod to pass through.
2. Attach the electrical box to the ceiling reinforcement and pass the $\frac{1}{16}$ " threaded rod through the box and secure it to the heavy duty hickey.
3. Pass the fixture wires and ground wire through the loop, canopy ring, center hole of canopy and the heavy duty hickey.
4. Pull ceiling wires down through the fixture box and make connection.
5. Screw loop only onto threaded pipe.
6. Hang the fixture on chain.
7. Secure the canopy with canopy ring.

07

Canopy Installation Instruction

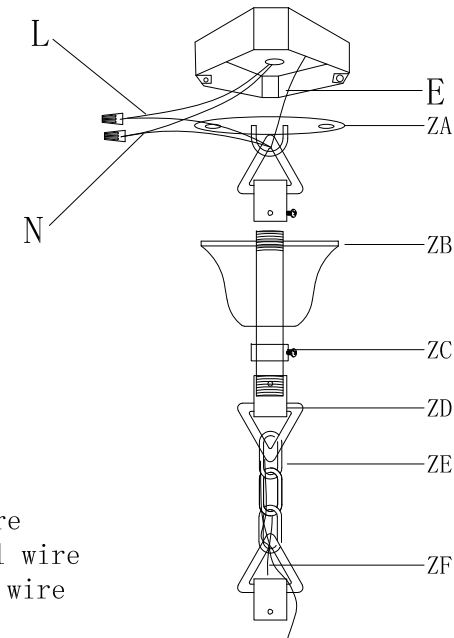

"L" = Hot wire
 "N" = Neutral wire
 "E" = Ground wire

Please read all instructions carefully. Before you proceed to install, make sure that the power supply is turned off and off until installation is complete. Please note that each part has been assigned a letter. Please proceed in alphabetical order.

1. Fix the crossbar (ZA) to the ceiling with the two crossbar screws.
2. Hang the Canopy ring (ZC) back up over the canopy (ZB), through metal rod (ZD) together.
3. Hang the electric main and ground wire through the chain (ZE), the Metal rod (ZD), the Loop and the crossbar (ZA) until the end of the electric main reaches the junction box where you can make the appropriate connections.
4. Be sure when connecting the wire use electrician approved junction caps.
5. Stow the excess wire in the junction box (ZA).
6. Raise the canopy (ZB).
7. Canopy ring (ZC), attach canopy (ZB) to ceiling, slide metal ring (ZC) over canopy lock (ZD) and hold the canopy (ZB).

08

Frame Assembly Diagram

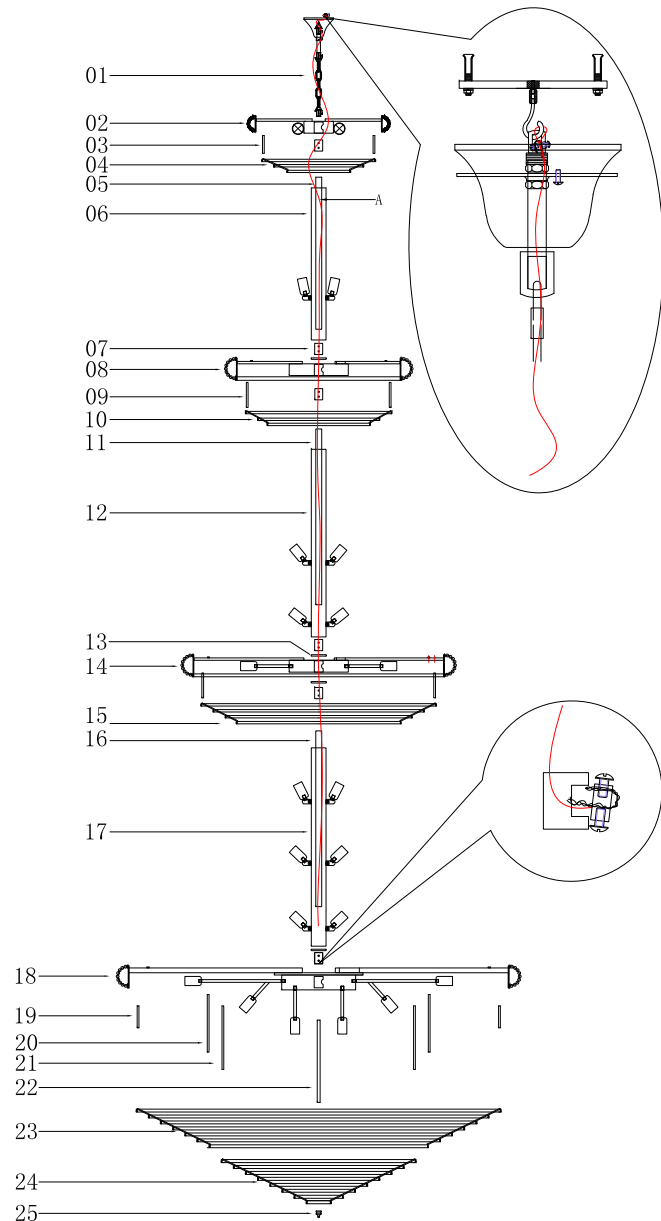

09

Step 3

Frame Assembly Instructions

Installation:

Please read all instructions carefully.
Before you proceed to install, make sure
that the power supply is turned off and
remains off until installation is complete.

Please note that each part has been assigned a number.
Please proceed in a numerical order.

1. Hang the chain (01) on the ceiling.
 2. Screw the bracket 2.95" (19) and bracket 7.7" (20) and bracket 8.46" (21) on the Lamp body(4) (18) dressing holes with M3*16 screws.
 3. Screw the frame(4) (23) on the bracket 2.95" (19) 、bracket 7.7"(20).
 4. Install the pipe cover (13) into the tier pipe 20.3" (06)、tier pipe 25" (12) and tier pipe 26.4" (17) both sides.
 5. Screw the bracket 10.5" (22) on the lamp body(4) (18) dressing holes screw the bottom lock (25) on the bracket 10.5" (22).
 6. Screw the bracket 3.35" (09) on the Lamp body(3) (14) dressing holes with M3*16 screws.
 7. Screw the threaded pipe 24.8" (16) on the lamp body(3) (14) with joint (07),
 8. Screw the bracket 3.35" (09) on the Lamp body(2) (08) lamp body (02) pass the tier pipe 25" (12), screw it well with chain (01) bottom ring.
 9. Pull up the steel wire through the lamp body arrive the Mounting bracket the fix it.
 10. Hang the all lamp on the chain (01) bottom.
 11. As the crystal dressing instruction, hang the crystal parts.
- NOTE: The fixture have the steel wire, you can't cut it, please use the steel wire and pull up it to the canopy to fix the fixture.

The end!

10

Step 4 Crystal Dressing Instructions

1. Hang crystal "C" "D" "E" "F" "G" .

Crystal Dressing Diagram



When dressing the chandelier with the crystals please remember to wear either rubber or cotton gloves. So as to prevent any damage or smudging on the crystals.

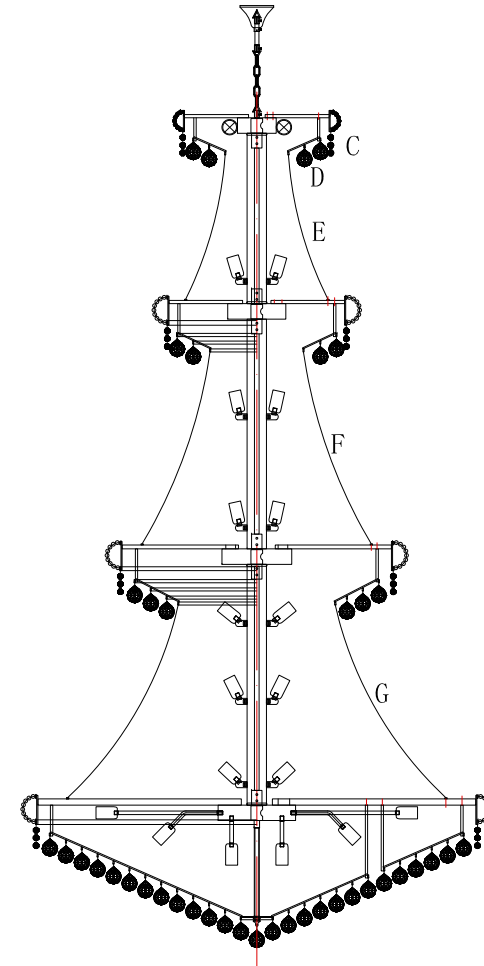

Congratulations !

You are now done installing your Elegant Lighting fixture. Sit back and admire each crystal as it will become the statement piece for your room/house.

Thank you.

Cleaning and Maintenance of Chandelier Frame

The finish on our chandelier frames and fixture frames is protected by a durable coating of lacquer. To clean, use a clean soft, dry cloth. Do not use any metal polishes, cleaners, abrasives or any substance which could remove the protective finish. Failure to follow these instructions automatically voids the guarantee.

Cleaning and Maintenance of Crystals

Wet a soft cotton fabric in clean warm water and wipe gently, then polish with a dry soft cotton fabric.

To Order Crystal Replacement Parts

Should you require replacement crystals or pins (the metal connectors attaching the crystals), contact the store where the product was purchased. For ease of ordering, you may use the original crystal trimming instructions provided with this product and circle the items you wish to order, indicating the quantity by writing the number needed adjacent to the circle. You will be contacted with prices prior to shipment. All orders must be pre-paid.

Elegant Lighting Warranty

The finish and frame of your new chandelier or fixture are warranted for a period of one (1) year from the date of purchase. Our company will, at its option, repair or replace any frame that has a defect in the materials or workmanship during the warranty period. All crystals are guaranteed for their original quality during the life of the chandelier. Breakage is not covered by this warranty.

To make a claim under this warranty, contact our customer service department.

A written return authorization form will be sent to you with specific instructions.

Returns and Conditions of Warranty

Returns must be pre-authorized by contacting the retailer where you made your purchase..Returns will only be accepted with a written return merchandise authorization and return shipping charges pre-paid. We reserve the right to inspect all returned merchandise to fully determine the nature of any defect. This guarantee shall not apply to any product that has been changed, altered or otherwise modified, nor shall it apply to any product that has been repaired or altered by anyone other than a pre-authorized facility. We will not be responsible for any breakage or damages incurred during transit, nor for crystal parts or metal frame part that have been subject to misuse, negligence, accident or inappropriate handling. Also, we will not be held responsible for damage incurred during improper installation or wiring by others, nor for damages resulting from a failure to follow the recommended maintenance or installation procedures. This guarantee is issued in lieu of any and all other guaranteed or warranty, whether written or implied and any and all other obligations or liabilities. Further, we neither authorize nor permit any other person or firm to assume for us, any liability in connection with the sale of our products.